

**Vieler Edelstahl-Fenstergriffe –
für anspruchsvolle Architektur**

Vieler stainless steel window handles –
for extraordinary architecture

Made by Vieler

3



Vieler Edelstahl-Fenstergriffe

Festdrehbare Beschlagtechnik. Grifführung über Rillenkugellager und Rastmechanik. Hochwertiges Material mit matt gebürsteter, pflegeleichter Oberfläche. Präzisionsvierkantstift 7 mm, 30 mm vorstehend, verzinkt, im Griffhals fixiert. Verdeckte Verschraubung mit Stütznocken und M5 Senkschrauben (Senkschrauben bauseits).

Vieler stainless steel window handles

Window hardware technology. Special roller race ball bearing. Click locking. Maintenance brushed satin stainless steel. Precise fitting spindle 7 mm, projection 30 mm, galvanised. Concealed face fixing with lugs and M5 machine bolts (on site).

Checkliste für Ihre Bestellungen

Checklist for ordering

für Fenstergriffe (FG) mit Vierkantstift 7 mm, 30 mm Überstand, ohne Schrauben
for window handles (FG) with 7 mm spindle, 30 mm projection but without fixing bolts

- **Bestell-Nummer**
Product code
- **Vierkantstift (wenn Überstand anders als 30 mm)**
Spindle projection (standard 30 mm)
- **Fensterichtung (nur bei FVK)**
Handling of window (only for FVK)
- **verschieden schließend (bei FV und FVK)**
Key to differ (only FV and FVK)

Maßübersicht Fenster-Rosetten

Rose dimensions for use with handles

Fenster-Rosette F
Window-Rose F

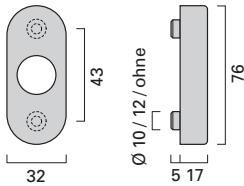

Fenster-Rosette, verschließbar, FV
Lockable window rose FV

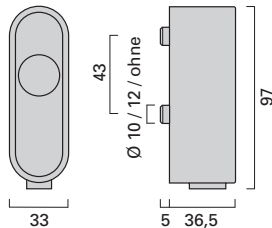

Schließanlagen-Beschlag SA
Window rose to suit Euro-profile cylinder SA

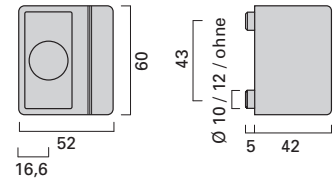

Maßübersicht Dornrosetten

Rose dimensions

Dornrosette mit Dornloch DRD
Rose with aperture DRD

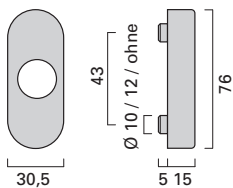

Dornrosette mit Vierkantkopf DRV
Rose with emergency release DRV

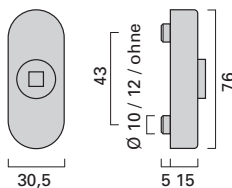

Dornrosette mit Dornloch und Verdeck, senkrecht DRS
Rose with aperture and swing cover (vertical) DRS

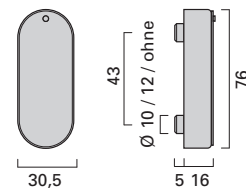

Dornrosette mit Dornloch und Verdeck, waagrecht DRW
Rose with aperture and swing cover (horizontal) DRW

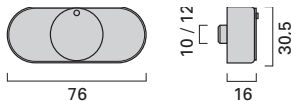

Vierkantstifte

Vierkantstifte werden standardmäßig mit 7 und 30 mm Überstand geliefert. Ein abweichender Überstand muss bei der Bestellung angegeben werden. Senkschrauben M5 sind bauseits zu beschaffen.

Hinweis:
Bei fehlender Bestellangabe liefern wir 7 mm Vierkantstift, 30 mm überstehend.























Spindles

Window handles are supplied with a 7 mm spindle with a projection of 30 mm. Other length spindles available to order. M5 fixings are not supplied.

Note:
If not advised at time of order 7 mm spindle with a projection of 30 mm will be supplied.

Modellübersicht
Vieler Edelstahl-Fenstergriffe

Model overview
Vieler stainless steel window handles

Modell Model	Seite Page	Modell Model	Seite Page	Modell Model	Seite Page	Modell Model	Seite Page	Modell Model	Seite Page	Modell Model	Seite Page
	3.04		3.08		3.12		3.16 NEU NEW		3.20		3.24
	3.05		3.09		3.13		3.17		3.21		3.04-3.23
	3.06		3.10		3.14		3.18		3.22	Foto zeigt Modell 121 Model 121 shown	
	3.07		3.11		3.15		3.19		3.23	Dorn- rosetten 3.26	

Vieler Edelstahl-Fenstergriff 112
Vieler stainless steel window handle 112



Produktfamilie Product family	Seite Page
Türdrücker 112 Lever handle 112	1.08
Türdrücker RT 112 für Rahmentüren Narrow stile lever handle RT 112	2.046

Fenster-Rosette F
Window rose type F
76 x 32 x 17 mm



Fenster-Rosette FV
verschießbar
Window rose type FV
lockable
97 x 32 x 37 mm



ENV
1627

Einbruch-
hemmung
Burglar
resistance

Fenster-Rosette FVK
verschießbar, nur
für Spezialgetriebe mit
geänderter Schaltfolge
Window rose type FVK
lockable, only
for tilt/turn windows
97 x 32 x 37 mm



ENV
1627

Einbruch-
hemmung
Burglar
resistance



ohne Stütznocken
without lugs

Stütznocken Ø 10 mm
with Ø 10 mm lugs

Stütznocken Ø 12 mm
with Ø 12 mm lugs

ER.FG.112.F

ER.FG.112.F10

ER.FG.112.F12

ER.FG.112.FV

ER.FG.112.FV10

ER.FG.112.FV12

ER.FG.112.FVK

ER.FG.112.FVK10

ER.FG.112.FVK12

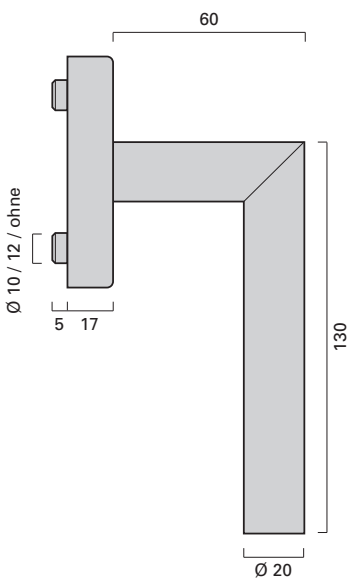

Schaltfolge
Operation

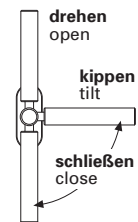

Vieler Edelstahl-Fenstergriff 117
Vieler stainless steel window handle 117



Produktfamilie Product family	Seite Page
Türdrücker 117 Lever handle 117	1.12
Türdrücker RT808 für Rahmentüren Narrow stile lever handle RT808	2.22

Fenster-Rosette F
Window rose type F
76 x 32 x 17 mm



Fenster-Rosette FV
verschießbar
Window rose type FV
lockable
97 x 32 x 37 mm



**ENV
1627**

**Einbruch-
hemmung**
Burglar
resistance

Fenster-Rosette FVK
verschießbar, nur
für Spezialgetriebe mit
geänderter Schaltfolge
Window rose type FVK
lockable, only
for tilt/turn windows
97 x 32 x 37 mm



**ENV
1627**

**Einbruch-
hemmung**
Burglar
resistance



ohne Stütznocken
without lugs

Stütznocken Ø 10 mm
with Ø 10 mm lugs

Stütznocken Ø 12 mm
with Ø 12 mm lugs

ER.FG.117.F

ER.FG.117.F10

ER.FG.117.F12

ER.FG.117.FV

ER.FG.117.FV10

ER.FG.117.FV12

ER.FG.117.FVK

ER.FG.117.FVK10

ER.FG.117.FVK12

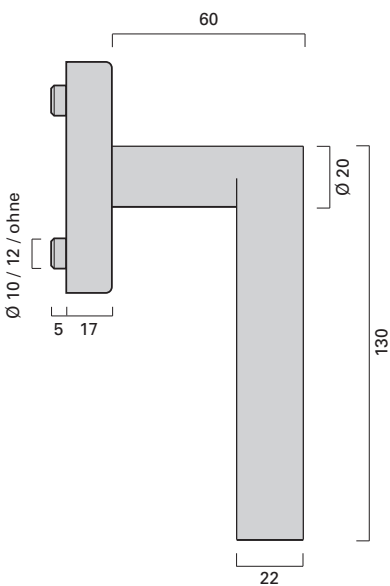

Schaltfolge
Operation

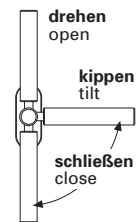

Vieler Edelstahl-Fenstergriff 121
Vieler stainless steel window handle 121

Produktfamilie
Product family

Seite
Page

Türdrücker 121
Lever handle 121

1.14



Fenster-Rosette F
Window rose type F
76 x 32 x 17 mm



Fenster-Rosette FV
verschießbar
Window rose type FV
lockable
97 x 32 x 37 mm



ENV
1627

Einbruch-
hemmung
Burglar
resistance

Fenster-Rosette FVK
verschießbar, nur
für Spezialgetriebe mit
geänderter Schaltfolge
Window rose type FVK
lockable, only
for tilt/turn windows
97 x 32 x 37 mm



ENV
1627

Einbruch-
hemmung
Burglar
resistance

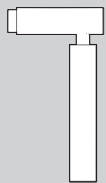

ohne Stütznocken
without lugs

Stütznocken Ø 10 mm
with Ø 10 mm lugs

Stütznocken Ø 12 mm
with Ø 12 mm lugs

ER.FG.121.F

ER.FG.121.F10

ER.FG.121.F12

ER.FG.121.FV

ER.FG.121.FV10

ER.FG.121.FV12

ER.FG.121.FVK

ER.FG.121.FVK10

ER.FG.121.FVK12

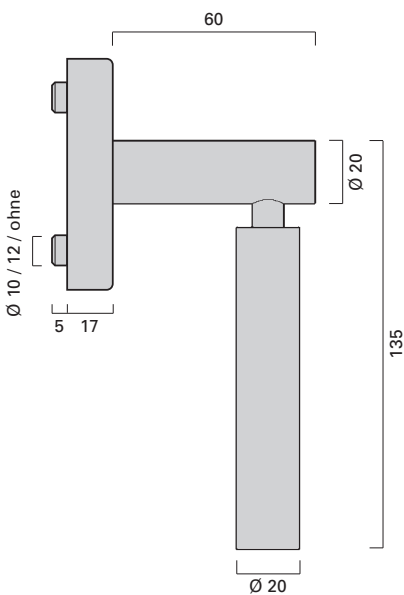

Schaltfolge
Operation

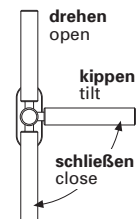

Vieler Edelstahl-Fenstergriff 124
Vieler stainless steel window handle 124

Produktfamilie
Product family

Seite
Page

Türdrücker 124
Lever handle 124

1.16



Fenster-Rosette F
Window rose type F
76 x 32 x 17 mm

Fenster-Rosette FV
verschießbar
Window rose type FV
lockable
97 x 32 x 37 mm

Fenster-Rosette FVK
verschießbar, nur für Spezialgetriebe mit geänderter Schaltfolge
Window rose type FVK
lockable, only for tilt/turn windows
97 x 32 x 37 mm



ENV
1627

Einbruch-
hemmung
Burglar
resistance

ENV
1627

Einbruch-
hemmung
Burglar
resistance

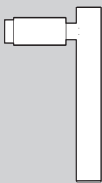

ohne Stütznocken
without lugs

Stütznocken Ø 10 mm
with Ø 10 mm lugs

Stütznocken Ø 12 mm
with Ø 12 mm lugs

ER.FG.124.F

ER.FG.124.F10

ER.FG.124.F12

ER.FG.124.FV

ER.FG.124.FV10

ER.FG.124.FV12

ER.FG.124.FVK

ER.FG.124.FVK10

ER.FG.124.FVK12

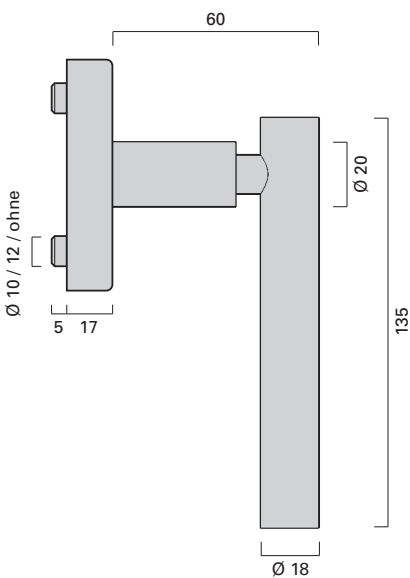

Schaltfolge
Operation

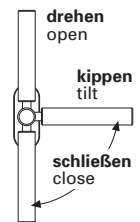

Vieler Edelstahl-Fenstergriff 132
Vieler stainless steel window handle 132



Produktfamilie Product family	Seite Page
Türdrücker 132 Lever handle 132	1.18
Türdrücker RT 142 für Rahmentüren Narrow stile lever handle RT 142	2.08

Fenster-Rosette F
Window rose type F
76 x 32 x 17 mm



Fenster-Rosette FV
verschießbar
Window rose type FV
lockable
97 x 32 x 37 mm



**ENV
1627**

**Einbruch-
hemmung**
Burglar
resistance

Fenster-Rosette FVK
verschießbar, nur
für Spezialgetriebe mit
geänderter Schaltfolge
Window rose type FVK
lockable, only
for tilt/turn windows
97 x 32 x 37 mm



**ENV
1627**

**Einbruch-
hemmung**
Burglar
resistance



ohne Stütznocken
without lugs

Stütznocken Ø 10 mm
with Ø 10 mm lugs

Stütznocken Ø 12 mm
with Ø 12 mm lugs

ER.FG.132.F

ER.FG.132.F10

ER.FG.132.F12

ER.FG.132.FV

ER.FG.132.FV10

ER.FG.132.FV12

ER.FG.132.FVK

ER.FG.132.FVK10

ER.FG.132.FVK12

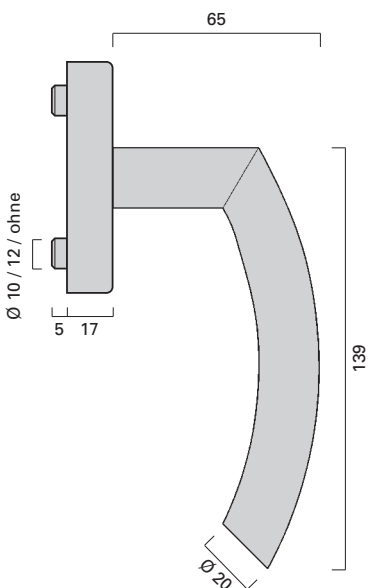

Schaltfolge
Operation

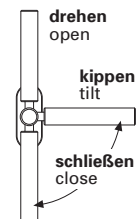

Vieler Edelstahl-Fenstergriff 133
Vieler stainless steel window handle 133

Produktfamilie
Product family

Seite
Page

Türdrücker 133
Lever handle 133

1.20



Fenster-Rosette F
Window rose type F
76 x 32 x 17 mm



Fenster-Rosette FV
verschießbar
Window rose type FV
lockable
97 x 32 x 37 mm



ENV
1627

Einbruch-
hemmung
Burglar
resistance

Fenster-Rosette FVK
verschießbar, nur
für Spezialgetriebe mit
geänderter Schaltfolge
Window rose type FVK
lockable, only
for tilt/turn windows
97 x 32 x 37 mm



ENV
1627

Einbruch-
hemmung
Burglar
resistance



ohne Stütznocken
without lugs

Stütznocken Ø 10 mm
with Ø 10 mm lugs

Stütznocken Ø 12 mm
with Ø 12 mm lugs

ER.FG.133.F

ER.FG.133.F10

ER.FG.133.F12

ER.FG.133.FV

ER.FG.133.FV10

ER.FG.133.FV12

ER.FG.133.FVK

ER.FG.133.FVK10

ER.FG.133.FVK12

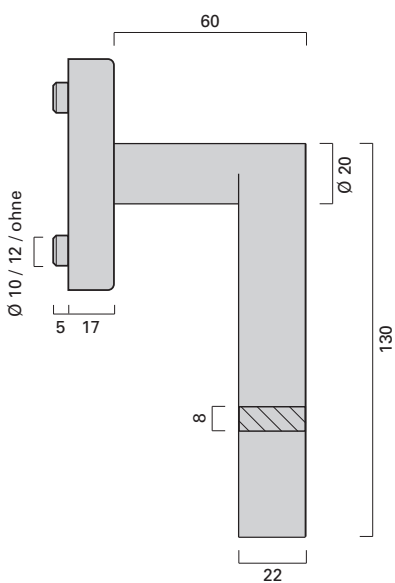

Schaltfolge
Operation

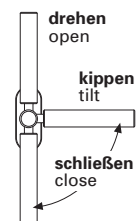

Vieler Edelstahl-Fenstergriff 134
Vieler stainless steel window handle 134

Produktfamilie
Product family

Seite
Page

Türdrücker 134
Lever handle 134

1.22



Fenster-Rosette F
Window rose type F
76 x 32 x 17 mm

Fenster-Rosette FV
verschießbar
Window rose type FV
lockable
97 x 32 x 37 mm

Fenster-Rosette FVK
verschießbar, nur für Spezialgetriebe mit geänderter Schaltfolge
Window rose type FVK
lockable, only for tilt/turn windows
97 x 32 x 37 mm



ENV
1627

Einbruch-
hemmung
Burglar
resistance

ENV
1627

Einbruch-
hemmung
Burglar
resistance



ohne Stütznocken
without lugs

Stütznocken Ø 10 mm
with Ø 10 mm lugs

Stütznocken Ø 12 mm
with Ø 12 mm lugs

ER.FG.134.F

ER.FG.134.F10

ER.FG.134.F12

ER.FG.134.FV

ER.FG.134.FV10

ER.FG.134.FV12

ER.FG.134.FVK

ER.FG.134.FVK10

ER.FG.134.FVK12

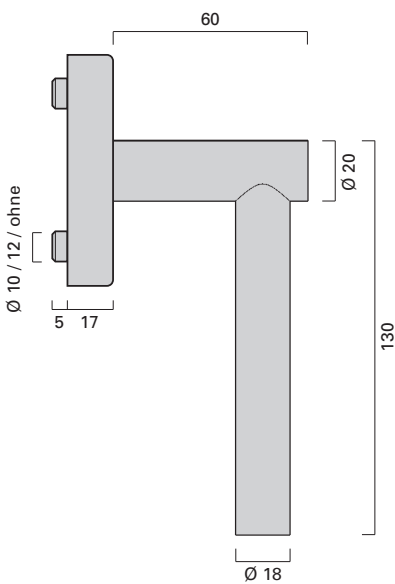

Schaltfolge
Operation

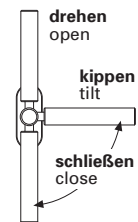

Vieler Edelstahl-Fenstergriff 135
Vieler stainless steel window handle 135

Produktfamilie
Product family

Seite
Page

Türdrücker 135
Lever handle 135

1.24



Fenster-Rosette F
Window rose type F
76 x 32 x 17 mm



Fenster-Rosette FV
verschießbar
Window rose type FV
lockable
97 x 32 x 37 mm



ENV
1627

Einbruch-
hemmung
Burglar
resistance

Fenster-Rosette FVK
verschießbar, nur
für Spezialgetriebe mit
geänderter Schaltfolge
Window rose type FVK
lockable, only
for tilt/turn windows
97 x 32 x 37 mm



ENV
1627

Einbruch-
hemmung
Burglar
resistance



ohne Stütznocken
without lugs

Stütznocken Ø 10 mm
with Ø 10 mm lugs

Stütznocken Ø 12 mm
with Ø 12 mm lugs

ER.FG.135.F

ER.FG.135.F10

ER.FG.135.F12

ER.FG.135.FV

ER.FG.135.FV10

ER.FG.135.FV12

ER.FG.135.FVK

ER.FG.135.FVK10

ER.FG.135.FVK12

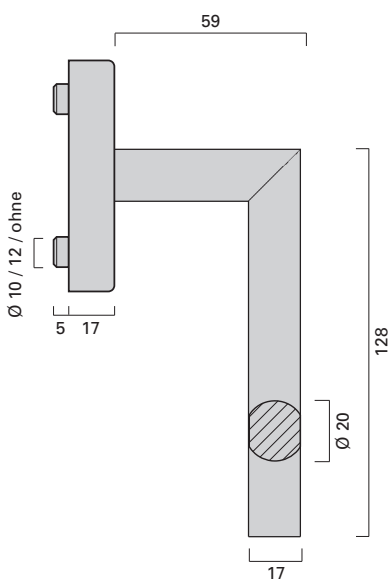

Schaltfolge
Operation

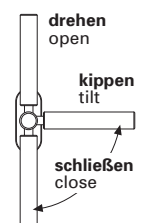

Vieler Edelstahl-Fenstergriff 143
Vieler stainless steel window handle 143

Produktfamilie
Product family

Seite
Page

Türdrücker 143
Lever handle 143

1.28



Fenster-Rosette F
Window rose type F
76 x 32 x 17 mm



Fenster-Rosette FV
verschießbar
Window rose type FV
lockable
97 x 32 x 37 mm



ENV
1627

Einbruch-
hemmung
Burglar
resistance

Fenster-Rosette FVK
verschießbar, nur
für Spezialgetriebe mit
geänderter Schaltfolge
Window rose type FVK
lockable, only
for tilt/turn windows
97 x 32 x 37 mm



ENV
1627

Einbruch-
hemmung
Burglar
resistance



ohne Stütznocken
without lugs

Stütznocken Ø 10 mm
with Ø 10 mm lugs

Stütznocken Ø 12 mm
with Ø 12 mm lugs

ER.FG.143.F

ER.FG.143.F10

ER.FG.143.F12

ER.FG.143.FV

ER.FG.143.FV10

ER.FG.143.FV12

ER.FG.143.FVK

ER.FG.143.FVK10

ER.FG.143.FVK12

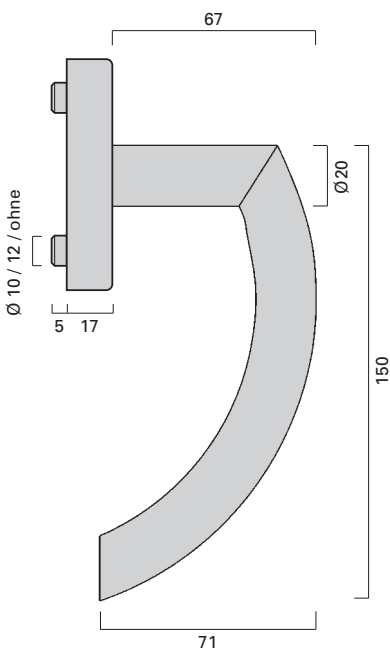

Schaltfolge
Operation

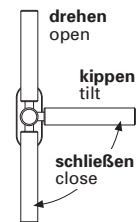

Vieler Edelstahl-Fenstergriff 144
Vieler stainless steel window handle 144



Produktfamilie Product family	Seite Page
Türdrücker 144 Lever handle 144	1.30
Türdrücker RT 524 für Rahmentüren Narrow stile lever handle RT 524	2.14

Fenster-Rosette F
Window rose type F
76 x 32 x 17 mm



Fenster-Rosette FV
verschießbar
Window rose type FV
lockable
97 x 32 x 37 mm



**ENV
1627**

**Einbruch-
hemmung**
Burglar
resistance

Fenster-Rosette FVK
verschießbar, nur
für Spezialgetriebe mit
geänderter Schaltfolge
Window rose type FVK
lockable, only
for tilt/turn windows
97 x 32 x 37 mm



**ENV
1627**

**Einbruch-
hemmung**
Burglar
resistance



ohne Stütznocken
without lugs

Stütznocken Ø 10 mm
with Ø 10 mm lugs

Stütznocken Ø 12 mm
with Ø 12 mm lugs

ER.FG.144.F

ER.FG.144.F10

ER.FG.144.F12

ER.FG.144.FV

ER.FG.144.FV10

ER.FG.144.FV12

ER.FG.144.FVK

ER.FG.144.FVK10

ER.FG.144.FVK12

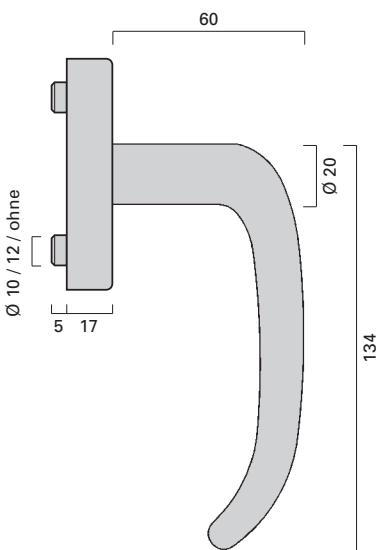

Schaltfolge
Operation

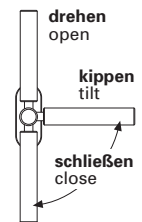

Vieler Edelstahl-Fenstergriff 521
Vieler stainless steel window handle 521

Produktfamilie
Product family

Seite
Page

Türdrücker 521
Lever handle 521

1.36

Türdrücker RT 522 für Rahmentüren
Narrow stile lever handle RT 522

2.12



Fenster-Rosette F
Window rose type F
76 x 32 x 17 mm

Fenster-Rosette FV
verschießbar
Window rose type FV
lockable
97 x 32 x 37 mm

Fenster-Rosette FVK
verschießbar, nur für Spezialgetriebe mit geänderter Schaltfolge
Window rose type FVK
lockable, only for tilt/turn windows
97 x 32 x 37 mm



ENV 1627

Einbruchhemmung
Burglar resistance

ENV 1627

Einbruchhemmung
Burglar resistance

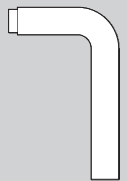

ohne Stütznocken
without lugs

Stütznocken Ø 10 mm
with Ø 10 mm lugs

Stütznocken Ø 12 mm
with Ø 12 mm lugs

ER.FG.521.F

ER.FG.521.F10

ER.FG.521.F12

ER.FG.521.FV

ER.FG.521.FV10

ER.FG.521.FV12

ER.FG.521.FVK

ER.FG.521.FVK10

ER.FG.521.FVK12

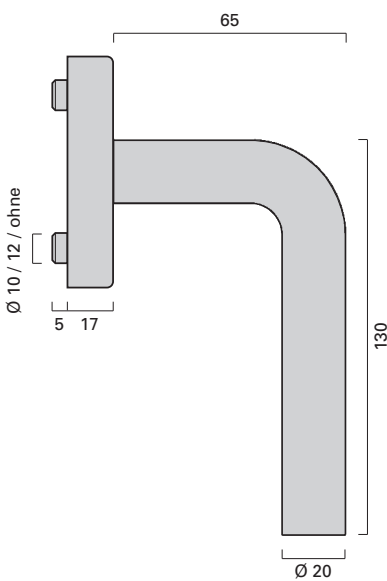

Schaltfolge
Operation

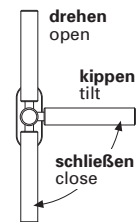

Vieler Edelstahl-Fenstergriff 522
Vieler stainless steel window handle 522



Produktfamilie Product family	Seite Page
Türdrücker 522 Lever handle 522	1.38
Türdrücker RT 522 für Rahmentüren Narrow stile lever handle RT 522	2.12

Fenster-Rosette F
Window rose type F
76 x 32 x 17 mm



Fenster-Rosette FV
verschießbar
Window rose type FV
lockable
97 x 32 x 37 mm



**ENV
1627**

**Einbruch-
hemmung**
Burglar
resistance

Fenster-Rosette FVK
**verschießbar, nur
für Spezialgetriebe mit
geänderter Schaltfolge**
Window rose type FVK
lockable, only
for tilt/turn windows
97 x 32 x 37 mm



**ENV
1627**

**Einbruch-
hemmung**
Burglar
resistance



ohne Stütznocken
without lugs

Stütznocken Ø 10 mm
with Ø 10 mm lugs

Stütznocken Ø 12 mm
with Ø 12 mm lugs

ER.FG.522.F

ER.FG.522.F10

ER.FG.522.F12

ER.FG.522.FV

ER.FG.522.FV10

ER.FG.522.FV12

ER.FG.522.FVK

ER.FG.522.FVK10

ER.FG.522.FVK12

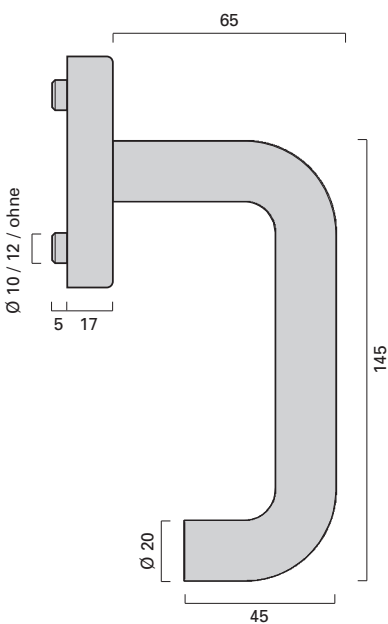

Schaltfolge
Operation

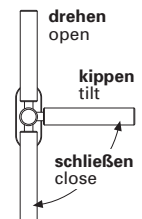

Vieler Edelstahl-Fenstergriff 548
Vieler stainless steel window handle 548

NEU
NEW

Produktfamilie
Product family

Seite
Page

Türdrücker 548
Lever handle 548

1.44

Türdrücker RT 548 für Rahmentüren
Narrow stile lever handle RT 548

2.16



Fenster-Rosette F
Window rose type F
76 x 32 x 17 mm



Fenster-Rosette FV
verschießbar
Window rose type FV
lockable
97 x 32 x 37 mm



ENV
1627

Einbruch-
hemmung
Burglar
resistance

Fenster-Rosette FVK
verschießbar, nur
für Spezialgetriebe mit
geänderter Schaltfolge
Window rose type FVK
lockable, only
for tilt/turn windows
97 x 32 x 37 mm



ENV
1627

Einbruch-
hemmung
Burglar
resistance



ohne Stütznocken
without lugs

Stütznocken Ø 10 mm
with Ø 10 mm lugs

Stütznocken Ø 12 mm
with Ø 12 mm lugs

ER.FG.548.F

ER.FG.548.F10

ER.FG.548.F12

ER.FG.548.FV

ER.FG.548.FV10

ER.FG.548.FV12

ER.FG.548.FVK

ER.FG.548.FVK10

ER.FG.548.FVK12

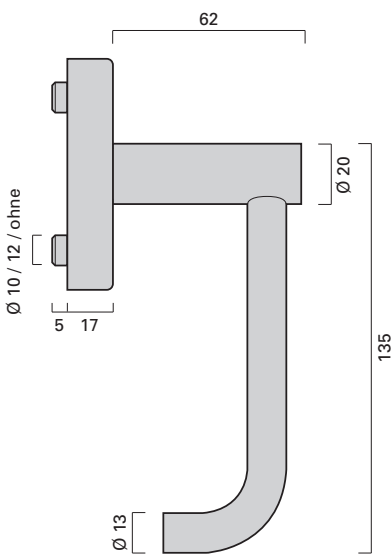

Schaltfolge
Operation

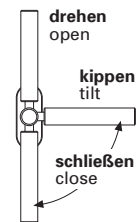

Vieler Edelstahl-Fenstergriff 595
Vieler stainless steel window handle 595

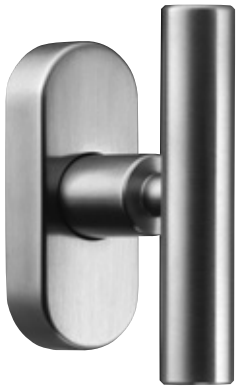

Fenster-Rosette F
Window rose type F
76 x 32 x 17 mm



Fenster-Rosette FV
verschießbar
Window rose type FV
lockable
97 x 32 x 37 mm



**ENV
1627**

**Einbruch-
hemmung**
Burglar
resistance

Fenster-Rosette FVK
**verschießbar, nur
für Spezialgetriebe mit
geänderter Schaltfolge**
Window rose type FVK
lockable, only
for tilt/turn windows
97 x 32 x 37 mm



**ENV
1627**

**Einbruch-
hemmung**
Burglar
resistance

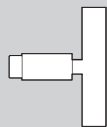

ohne Stütznocken
without lugs

Stütznocken Ø 10 mm
with Ø 10 mm lugs

Stütznocken Ø 12 mm
with Ø 12 mm lugs

ER.FG.595.F

ER.FG.595.F10

ER.FG.595.F12

ER.FG.595.FV

ER.FG.595.FV10

ER.FG.595.FV12

ER.FG.595.FVK

ER.FG.595.FVK10

ER.FG.595.FVK12

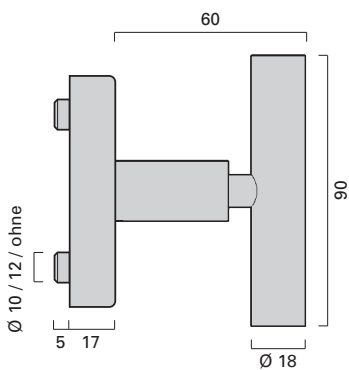

Schaltfolge
Operation

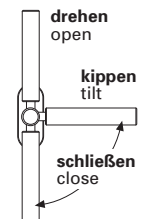

Vieler Edelstahl-Fenstergriff 612
Vieler stainless steel window handle 612



Produktfamilie Product family	Seite Page
Türdrücker 112 Lever handle 112	1.08
Türdrücker RT 112 für Rahmentüren Narrow stile lever handle RT 112	2.04

Fenster-Rosette F
Window rose type F
76 x 32 x 17 mm



Fenster-Rosette FV
verschießbar
Window rose type FV
lockable
97 x 32 x 37 mm



ENV
1627

Einbruch-
hemmung
Burglar
resistance

Fenster-Rosette FVK
verschießbar, nur
für Spezialgetriebe mit
geänderter Schaltfolge
Window rose type FVK
lockable, only
for tilt/turn windows
97 x 32 x 37 mm



ENV
1627

Einbruch-
hemmung
Burglar
resistance



ohne Stütznocken
without lugs

Stütznocken Ø 10 mm
with Ø 10 mm lugs

Stütznocken Ø 12 mm
with Ø 12 mm lugs

ER.FG.612.F

ER.FG.612.F10

ER.FG.612.F12

ER.FG.612.FV

ER.FG.612.FV10

ER.FG.612.FV12

ER.FG.612.FVK

ER.FG.612.FVK10

ER.FG.612.FVK12

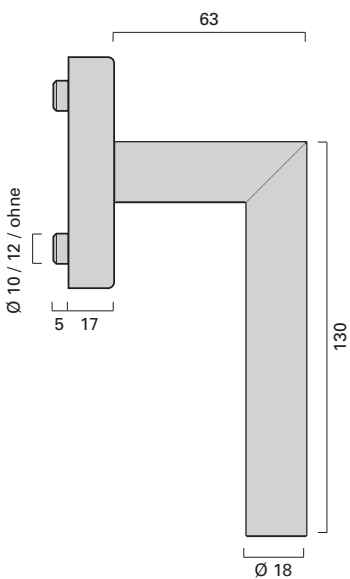

Schaltfolge
Operation

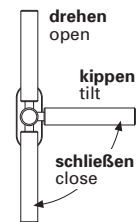

Vieler Edelstahl-Fenstergriff 621
Vieler stainless steel window handle 621



Produktfamilie Product family	Seite Page
Türdrücker 621 Lever handle 621	1.48
Türdrücker RT 522 für Rahmentüren Narrow stile lever handle RT 522	2.12

Fenster-Rosette F
Window rose type F
76 x 32 x 17 mm



Fenster-Rosette FV
verschießbar
Window rose type FV
lockable
97 x 32 x 37 mm



**ENV
1627**

**Einbruch-
hemmung**
Burglar
resistance

Fenster-Rosette FVK
verschießbar, nur
für Spezialgetriebe mit
geänderter Schaltfolge
Window rose type FVK
lockable, only
for tilt/turn windows
97 x 32 x 37 mm



**ENV
1627**

**Einbruch-
hemmung**
Burglar
resistance



ohne Stütznocken
without lugs

Stütznocken Ø 10 mm
with Ø 10 mm lugs

Stütznocken Ø 12 mm
with Ø 12 mm lugs

ER.FG.621.F

ER.FG.621.F10

ER.FG.621.F12

ER.FG.621.FV

ER.FG.621.FV10

ER.FG.621.FV12

ER.FG.621.FVK

ER.FG.621.FVK10

ER.FG.621.FVK12

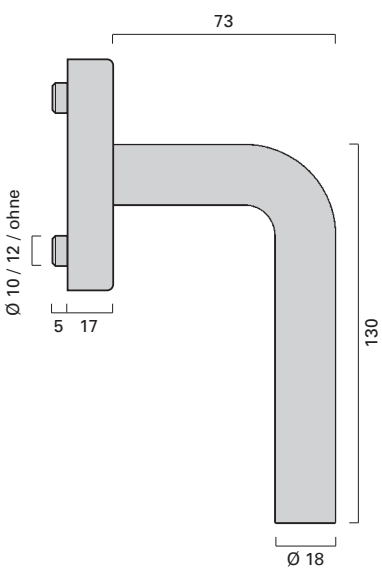

Schaltfolge
Operation

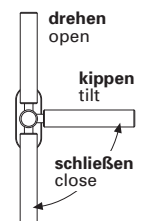

Vieler Edelstahl-Fenstergriff 622
Vieler stainless steel window handle 622



Produktfamilie	Seite
Product family	Page
Türdrücker 622 Lever handle 622	1.50
Türdrücker RT 522 für Rahmentüren Narrow stile lever handle RT 522	2.12

Fenster-Rosette F
Window rose type F
76 x 32 x 17 mm



Fenster-Rosette FV
verschießbar
Window rose type FV
lockable
97 x 32 x 37 mm



ENV
1627

Einbruch-
hemmung
Burglar
resistance

Fenster-Rosette FVK
verschießbar, nur
für Spezialgetriebe mit
geänderter Schaltfolge
Window rose type FVK
lockable, only
for tilt/turn windows
97 x 32 x 37 mm



ENV
1627

Einbruch-
hemmung
Burglar
resistance



ohne Stütznocken
without lugs

Stütznocken Ø 10 mm
with Ø 10 mm lugs

Stütznocken Ø 12 mm
with Ø 12 mm lugs

ER.FG.622.F

ER.FG.622.F10

ER.FG.622.F12

ER.FG.622.FV

ER.FG.622.FV10

ER.FG.622.FV12

ER.FG.622.FVK

ER.FG.622.FVK10

ER.FG.622.FVK12

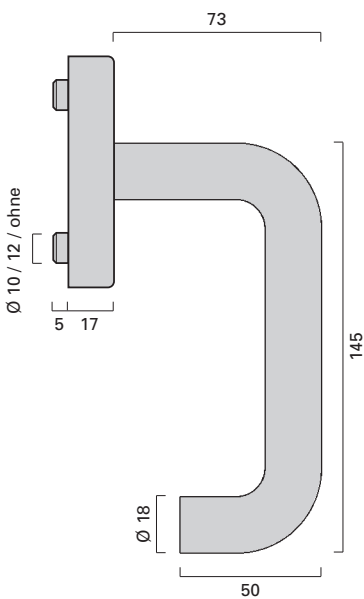

Schaltfolge
Operation

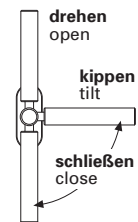

Vieler Edelstahl-Fenstergriff 801
Vieler stainless steel window handle 801



Produktfamilie Product family	Seite Page
Türdrücker 801 Lever handle 801	1.52
Türdrücker RT 803 für Rahmentüren Narrow stile lever handle RT 803	2.18

Fenster-Rosette F
Window rose type F
76 x 32 x 17 mm



Fenster-Rosette FV
verschießbar
Window rose type FV
lockable
97 x 32 x 37 mm



**ENV
1627**

**Einbruch-
hemmung**
Burglar
resistance

Fenster-Rosette FVK
verschießbar, nur
für Spezialgetriebe mit
geänderter Schaltfolge
Window rose type FVK
lockable, only
for tilt/turn windows
97 x 32 x 37 mm



**ENV
1627**

**Einbruch-
hemmung**
Burglar
resistance



ohne Stütznocken
without lugs

Stütznocken Ø 10 mm
with Ø 10 mm lugs

Stütznocken Ø 12 mm
with Ø 12 mm lugs

ER.FG.801.F

ER.FG.801.F10

ER.FG.801.F12

ER.FG.801.FV

ER.FG.801.FV10

ER.FG.801.FV12

ER.FG.801.FVK

ER.FG.801.FVK10

ER.FG.801.FVK12

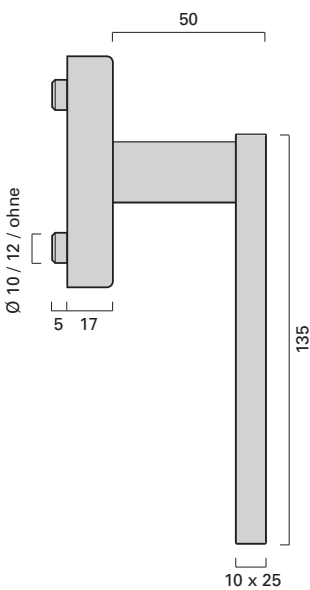

Schaltfolge
Operation

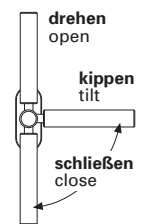

Vieler Edelstahl-Fenstergriff 804
Vieler stainless steel window handle 804



Produktfamilie Product family	Seite Page
Türdrücker 804 Lever handle 804	1.56
Türdrücker RT 806 für Rahmentüren Narrow stile lever handle RT 806	2.20

Fenster-Rosette F
Window rose type F
76 x 32 x 17 mm



Fenster-Rosette FV
verschießbar
Window rose type FV
lockable
97 x 32 x 37 mm



**ENV
1627**

**Einbruch-
hemmung**
Burglar
resistance

Fenster-Rosette FVK
**verschießbar, nur
für Spezialgetriebe mit
geänderter Schaltfolge**
Window rose type FVK
lockable, only
for tilt/turn windows
97 x 32 x 37 mm



**ENV
1627**

**Einbruch-
hemmung**
Burglar
resistance



ohne Stütznocken
without lugs

Stütznocken Ø 10 mm
with Ø 10 mm lugs

Stütznocken Ø 12 mm
with Ø 12 mm lugs

ER.FG.804.F

ER.FG.804.F10

ER.FG.804.F12

ER.FG.804.FV

ER.FG.804.FV10

ER.FG.804.FV12

ER.FG.804.FVK

ER.FG.804.FVK10

ER.FG.804.FVK12

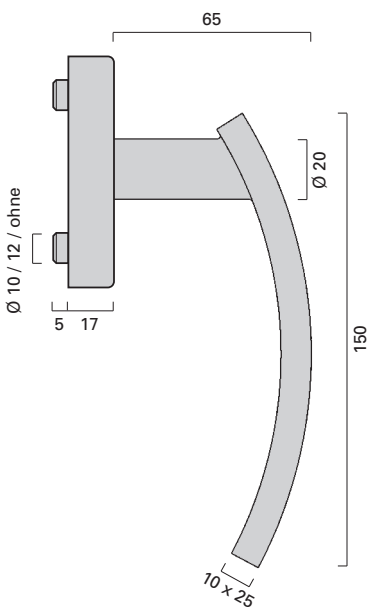

Schaltfolge
Operation

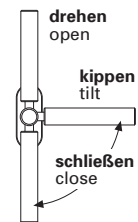

Vieler Edelstahl-Fenstergriff 809
Vieler stainless steel window handle 809

Produktfamilie
Product family

Seite
Page

Türdrücker 809
Lever handle 809

1.62

Designed by Peiyu Li



Fenster-Rosette F
Window rose type F
76 x 32 x 17 mm

Fenster-Rosette FV
verschießbar
Window rose type FV
lockable
97 x 32 x 37 mm

Fenster-Rosette FVK
verschießbar, nur für Spezialgetriebe mit geänderter Schaltfolge
Window rose type FVK
lockable, only for tilt/turn windows
97 x 32 x 37 mm



ENV 1627

Einbruchhemmung
Burglar resistance

ENV 1627

Einbruchhemmung
Burglar resistance



ohne Stütznocken
without lugs

Stütznocken Ø 10 mm
with Ø 10 mm lugs

Stütznocken Ø 12 mm
with Ø 12 mm lugs

ER.FG.809.F

ER.FG.809.F10

ER.FG.809.F12

ER.FG.809.FV

ER.FG.809.FV10

ER.FG.809.FV12

ER.FG.809.FVK

ER.FG.809.FVK10

ER.FG.809.FVK12

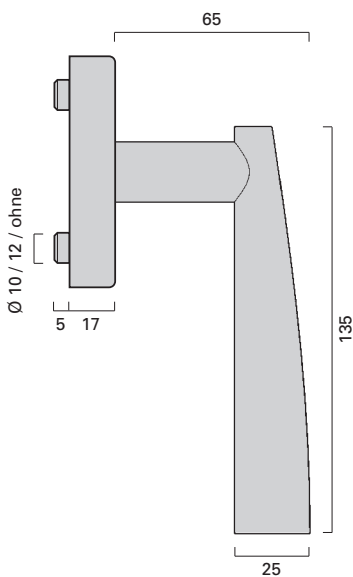

Schaltfolge
Operation

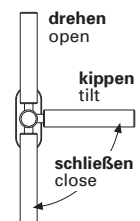

Vieler Edelstahl-Fensterbeschlag für Schließanlagen
Vieler stainless steel window handles to suit Euro-Profile cylinder



Abbildung Modell 522
Alle Modelle ausgenommen 595 lieferbar
Model 522 shown
All models except 595 are available

Bestellung am Beispiel des Fenstergriff 522
Reference no. refers to model 522

Festdrehbare Beschlagtechnik. Führung über Rillenkugellager und Rastmechanik. Hochwertiges Material mit matt gebürsteter, pflegeleichter Oberfläche. Präzisionsvierkantstift 7 mm, 30 mm vorstehend, verzinkt, im Griffhals fixiert. Verdeckte Verschraubung mit Stütznocken und M5 Senkschrauben (Profilhalbzylinder und Senkschrauben bauseits).

If it is necessary to supply lockable window handles under a master key system then you should consider model SA or SAK. Single Euro-profile cylinders can be provided by the cylinder manufacturer or hardware supplier under the building master key.

**ENV
1627**

**Einbruch-
hemmung**
Burglar
resistance

**Schließanlagen-
Beschlag SA**
Window rose SA
to suit Euro-Profile
cylinder
52 x 60 x 42 mm

**Schließanlagen-
beschlag SAK**
nur für Spezialgetriebe
mit geänderter Schaltfolge
Window rose SAK
to suit Euro-Profile
cylinder with tilt/turn
function
52 x 60 x 42 mm

ohne Stütznocken
without lugs

Stütznocken Ø 10 mm
with Ø 10 mm lugs

Stütznocken Ø 12 mm
with Ø 12 mm lugs

Preisberechnung:

SA: Siehe gewünschtes Fenstergriff-Modell ER.FG.xxx.F zuzgl. 136,50 €
SAK: Siehe gewünschtes Fenstergriff-Modell ER.FG.xxx.F zuzgl. 171,25 €
Siehe Seite 3.3-3.21

Price calculation:

SA: Price of ER.FG.xxx.F plus 136,50 €
SAK: Price of ER.FG.xxx.F plus 171,25 €
Please refer to page 3.3-3.21

ER.FG.522.SA

ER.FG.522.SA10

ER.FG.522.SA12

ER.FG.522.SAK

ER.FG.522.SAK10

ER.FG.522.SAK12

Schaltfolge
Operation

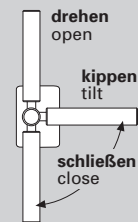

Verriegelungsbeschlag für 7 mm Vierkant
Window rose with 7 mm spindle adaptor

ohne Stütznocken
without lugs

Stütznocken Ø 10 mm
with Ø 10 mm lugs

Stütznocken Ø 12 mm
with Ø 12 mm lugs

ER.FG.520.SA

ER.FG.520.SA10

ER.FG.520.SA12

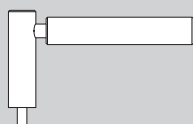

Dornschlüssel Verriegelungsbeschlag aus Edelstahl für 7 mm Vierkant
Release handle with 7 mm spindle

ZU.GDS7

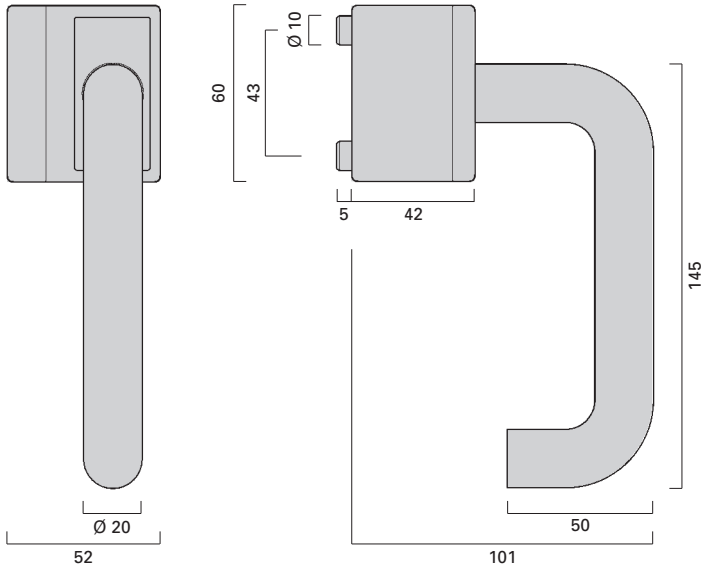

Produktfamilie
Product family

Türdrücker 522
Lever handle 522

Rahmentürdrücker RT522
Narrow stile lever handle RT 522

Seite
Page

1.38

2.12

Profil-Halbzylinder-Typbezeichnungen
Profil-Halbzylinder mit Freilauf

Type of Euro-profile cylinder
Half cylinder with free flow cam

BKS	B 3196 0901 B 3196 0902	rechts - right links - left
CES	810 1/2 / 83 B5 810 1/2 / 93 B5	rechts - right links - left
DOM	333 RNH MIWE 270°	Richtung rechts/links angeben Please advise hand right/left
EVVA	HZ/B-SW BL 32	Richtung rechts/links angeben Please advise hand right/left
IKON	532.SST = 330-90 532.SST = 270-30	rechts - right links - left
KABA	System Gemini 2HZ.30.NI.FL270 System Quattro 4HZ.30.NI.FL270	mit Relativbewegung 120° Richtung angeben Please advise hand
KESO	21.499.068 21.499.069	rechts - right links - left
PFAFFENHAIN	mit 5 Zuhaltungen 352-1031 31 mm Länge mit 6 Zuhaltungen 452-1030 30 mm Länge	Relativbewegung + Richtung angeben Please advise hand
WILKA	Nr. 1416 R Nr. 1416 L	rechts - right links - left
WINKHAUS	02 / Z 40 A	Richtung rechts/links angeben Please advise hand right/left

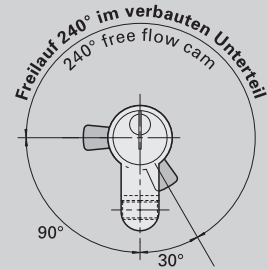
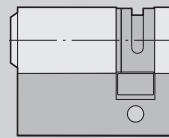



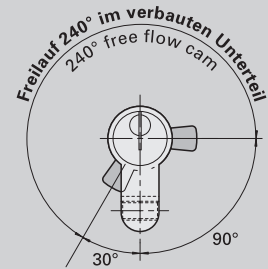

Ausführung rechts
Right hand



Ausführung links
Left hand

Vieler Edelstahl-Dornrosetten
Vieler stainless steel window rose

	Dornrosette DRV mit 8 mm Vierkantkopf Lockable rose DRV 8 mm key 76 x 30,5 x 15 mm	Dornrosette DRD mit Dornloch Rose DRD without handle 76 x 30,5 x 15 mm	Dornrosette DRS senkrecht mit Dornloch und Verdeck Rose DRS without handle, with swing cover (vertical) 76 x 30,5 x 17 mm	Dornrosette DRW waagrecht mit Dornloch und Verdeck Rose DRW without handle, with swing cover (horizontal) 76 x 30,5 x 16 mm
				
ohne Stütznocken without lugs	ER.DRV	ER.DRD	ER.DRS	ER.DRW
Stütznocken Ø 10 mm with Ø 10 mm lugs	ER.DRV10	ER.DRD10	ER.DRS10	ER.DRW10
Stütznocken Ø 12 mm with Ø 12 mm lugs	ER.DRV12	ER.DRD12	ER.DRS12	ER.DRW12



Dornschlüssel, klein, für 8 mm Vierkant
Key to operate DRV

ZU.DS8



Dornschlüssel, groß, für 8 mm Vierkant
Key to operate DRV

ZU.GDS8